

Work happily



V1.0

naggura'swop

naggura.com

Unsere Produkte



S502WHITE



S502GREY



Die Swop 502 ist eine viermotorige Kosmetikliege mit optimaler Stabilität und superkompaktem Gestell.

Holz, Metall oder Pmma

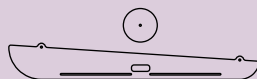

Kollektionen

Nordic
METALL

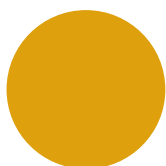

Yellow

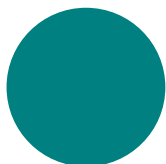

Blue

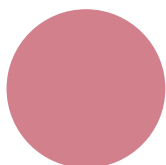

Pink

Foll
METALL

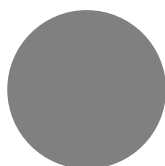

Ash

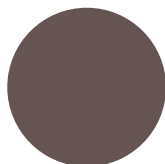

Clay

Iron
METALL

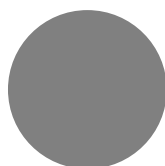

Inox

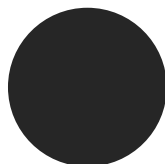

Black

Om
HOLZ



Oak



Wenge

Techno
PMMA



Fluor



Fuxia



Ice

S502

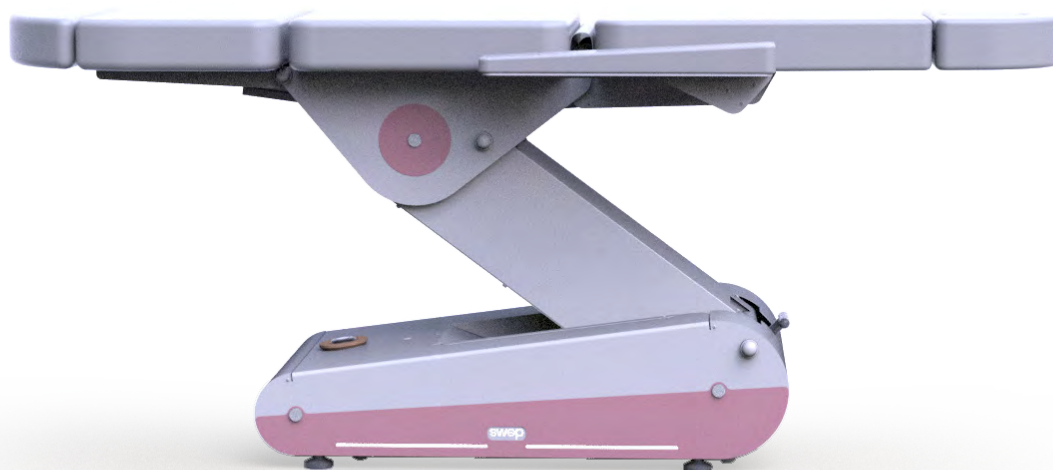
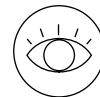

Abmessungen

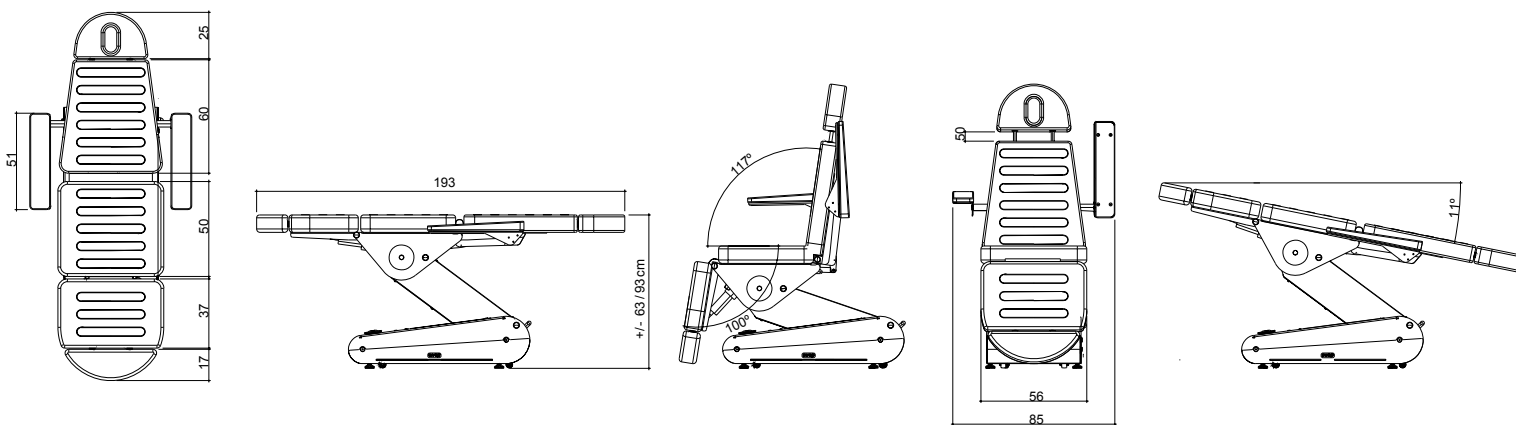

Technische Angaben

MOTOREN
4 Motoren

ABMESSUNGEN (LÄNGE X BREITE)
193 x 85 cm

HÖHE (MIN. UND MAX.)
63/93 cm

GEWICHT
105 kg

POLSTERDICKE
10 cm

DICHTE
30 kg/m³

BELASTBARKEIT
175 kg

BEDIENUNG
Handfernbedienung (serienmäßige Ausstattung)/
Fußfernbedienung (optional)

STROMVERSORUNG
230 V - 50/60 Hz

MAX. INTENSITÄT
2 A

ELEKTRISCHER MOTOR
6.000 N

POLSTERUNG

100% Vinyl-Beschichtung

Permablok 3 Advanced Vinyl Protection (gegen Keime und Abrieb), UV-beständig, hohe Beständigkeit 300K, graue Farbe

Permaguard Advanced Vinyl Protection (gegen Keime und Abrieb), UV-beständig, hohe Beständigkeit 100K, weiße Farbe